



Recent advances in optical telecommunications / Avancées récentes en télécommunications optiques

Submarine networks: evolution, not revolution

Olivier Gautheron

Alcatel-Lucent, Submarine Networks Division, 91625 Nozay, France

Available online 2 December 2008

Abstract

We have described in a previous issue of the Comptes Rendus Physique of January–February 2003 how the wavelength division multiplexing technique enabled us to increase drastically the transmission capacity per fiber over trans-Atlantic distances (from 1×5 Gbit/s in 1995 up to 42×10 Gbit/s in 2001). Then, the crash of the internet bubble reduced the need for higher capacity, but, recently, the demand in trans-Pacific links has led to the deployment of new technologies such as the differential phase shift keying modulation format. This new modulation format also enables the upgrading of existing links beyond their design capacities. We illustrate the benefit of this new modulation format and also discuss the capabilities to increase the bit rate from 10 Gb/s to 40 Gb/s per wavelength. **To cite this article:** *O. Gautheron, C. R. Physique 9 (2008).*

© 2008 Académie des sciences. Published by Elsevier Masson SAS. All rights reserved.

Résumé

Réseaux sous-marins : évolution sans révolution. Nous avons montré dans le numéro de janvier–février 2003 des Comptes Rendus de Physique comment le multiplexage en longueur d'onde avait permis d'accroître sensiblement la capacité de transmission par fibre à-travers l'océan Atlantique (de 1×5 Gbit/s en 1995 à 42×10 Gbit/s en 2001). Depuis, l'éclatement de la bulle internet a ralenti l'accroissement de capacité mais récemment le besoin de grandes liaisons à-travers l'océan Pacifique a permis l'industrialisation de nouvelles technologies telle que la transmission à modulation de phase différentielle. Ce format de modulation permet également d'augmenter la capacité des fibres déjà déployées au-delà de leurs capacités maximales initiales. Nous discuterons également rapidement la possibilité de transmettre des canaux modulés à 40 Gb/s sur des liens sous-marins. **Pour citer cet article :** *O. Gautheron, C. R. Physique 9 (2008).*

© 2008 Académie des sciences. Published by Elsevier Masson SAS. All rights reserved.

Keywords: Wavelength division multiplexing; High bit rate modulation; Dispersion-slope-matched fiber; Erbium doped fiber amplifier; Chromatic dispersion; Differential phase shift keying; Forward error correction codes

Mots-clés : Multiplexage en longueur d'onde ; Modulation haut débit ; Fibre à pente de dispersion compensée ; Amplificateur optique à fibre dopé à l'erbium ; Dispersion chromatique ; Modulation de phase différentielle ; Codes correcteur d'erreur

1. Introduction

During the 1990s, the Wavelength Division Multiplexing (WDM) technique, in combination with gain flattened Erbium Doped Fiber Amplifier (EDFA) enabled the deployment of high capacity submarine systems across the oceans. All these optical communications systems employed conventional on-off-keyed (OOK) signals in either non-return-to-

E-mail address: olivier.gautheron@alcatel.fr.

Table 1

Design capacity of Trans-Atlantic (Apollo) and Trans-Pacific (China–US & Tyco Global Network) submarine links.

Name of the link	Apollo	China–US	TGN Pacific (Japan–US)
Length of the link	6700 km	11 500 km	9000 km
Maximum capacity/fiber	80×10 Gb/s	8×2.5 Gb/s	64×10 Gb/s
Repeater spacing	45 km	50 km	45 km
Type of fiber	NZDSF	NZDSF	DSMF



Fig. 1. Final assembly of a repeater (left) and storage of repeaters in cable factory before loading on the ship (right).

zero (NRZ) or return-to-zero (RZ) format. In some cases, phase modulation was added in a non-information bearing way on top of these OOK modulation: this is the case for the chirped return to zero (CRZ) format that has been widely deployed in the 10 Gb/s WDM systems between 1995 and 2001 [1].

Table 1 gives the highest capacity of ultra long haul system (longer than 6000 km) deployed until 2007. All these systems use OOK modulation scheme.

It should be underlined that Apollo and China–USA used conventional Non-Zero-Dispersion-Shifted Fiber (NZDSF) while TGN Pacific was the sole link deployed before 2007 with Dispersion-Slope-Matched fiber (DSMF) [2]. Note that in [1], the DSMF was named DSCF for Dispersion-Slope-Compensated Fiber.

Although we mentioned in [1] potential evolution in submarine optical amplification based on Raman amplification or C + L band EDFA, none of these techniques have been implemented. Moreover, the submarine systems deployed until 2007 did not offer more capacity than those deployed in 2003.

No technical evolution has been deployed during the period 2003–2007. In 2008, however, evolution comes from the terminal performance: thanks mainly to the improvement of error correcting codes and the introduction of phase modulation instead of intensity modulation of the signal, the repeater spacing has been significantly increased. The transmission bit rate per wavelength is, nevertheless, still 10 Gb/s, and the transmission capacity has not increased compared to 2003, since the clear priority of the customer in the submarine market was to reduce the cost of submarine links rather than increasing the transmission capacity. This is why we can talk about an evolution rather than a revolution. Fig. 1 represents the storage of repeaters in a ship and final assembly of repeaters in the factory: these are the same equipment used 6 years ago.

So, the main evolution is coming from the terminal with the introduction of more efficient Forward Error Correcting codes (FEC) and a new modulation format based on Phase-Shift-Keying (PSK). Actually, the PSK modulation scheme is being deployed by Alcatel-Lucent Submarine Networks in 2008 for the first time in submarine systems (Sydney–Hawaii link). In this new modulation format, due to the lack of an absolute phase reference in direct detection receivers, the phase of the preceding bit is used as a relative phase reference for demodulation. This results in the differential-phase-shift-keyed (DPSK) format. Finally, an intensity RZ carving can be added to the DPSK data signals to improve the transmission performance, thus forming the RZ-DPSK modulation scheme. Using a balanced receiver, DPSK has the advantage of requiring about 3 dB lower optical-signal-to-noise-ratio (OSNR) than OOK schemes to reach a given bit error ratio (BER) [3]. Therefore, this new modulation format enables one to reach very high capacities and

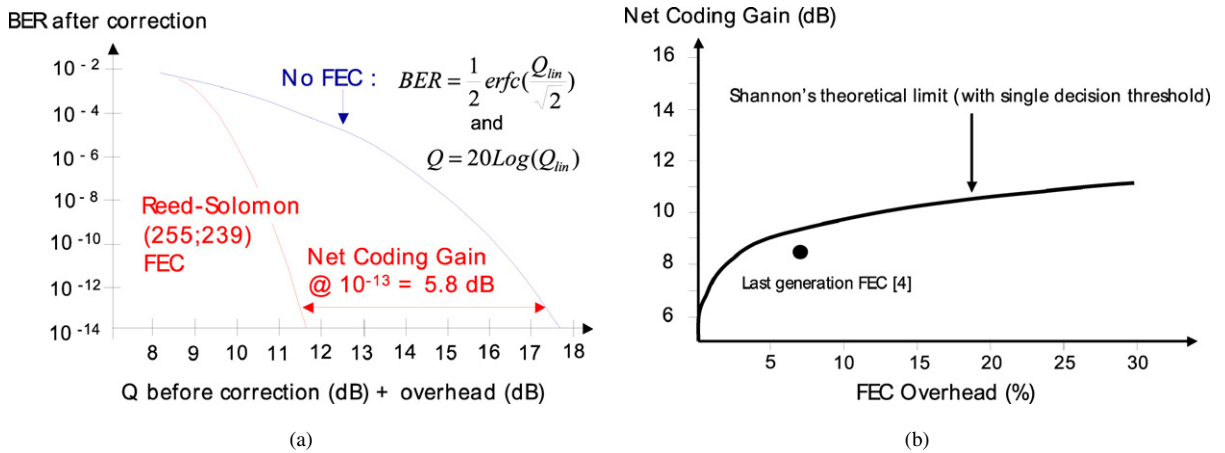

Fig. 2. (a) BER after correction versus the received Q factor before correction. (b) Theoretical Shannon limit of FEC based on a single decision threshold versus the size of the FEC overhead.

longer repeater spacing on ultra long distances, as well as upgrading existing systems beyond their maximum design capacity. The transmission bit rate per channel is still 10 Gb/s, but laboratory experiments have been performed to find a solution to transmit WDM 40 Gb/s capacities without increasing too much the repeater count compared to the WDM 10 Gb/s solution: this is far from being achieved but some encouraging results will be presented in the last part of this article.

2. Evolution of FEC efficiency between 2001 and 2008

The transmission quality is evaluated by measuring the Bit Error Ratio (BER). When the noise distribution is Gaussian, we have the relationship:

$$BER = \frac{1}{2} \operatorname{erfc}\left(\frac{Q_{lin}}{\sqrt{2}}\right) \tag{1}$$

with: $Q_{lin} = (I_1 - I_0)/(\sigma_1 - \sigma_0)$ where $\operatorname{erfc}(x) = 1 - \frac{2}{\sqrt{\pi}} \int_0^x e^{-y^2} dy$ and I_1 (I_0) is the mark (space) electrical level.

In practice, the transmission quality is expressed through the Q factor deduced from the measured BER by the formula (1).

In absence of pulse distortion, the Q factor can be directly deduced from the Optical Signal-to-Noise-Ratio (OSNR) [4]. This is the reason why the Q factor is usually expressed in dB rather than in linear values: $Q = 20 \operatorname{Log}(Q_{lin})$ expressed in dB. This permits one to evaluate the transmission quality margin in dB and to translate easily this margin in OSNR margin and distance margin between adjacent repeaters for example. In Fig. 2(a), the curve without FEC represents the correspondence between the BER and the Q factor through formula (1).

The transmission quality of submarine networks required by the customers is a BER of $1E - 13$. This means that without FEC, the Q factor of the received data should be 17.3 dB.

The objective of the FEC is to reduce the required Q factor before correction (while still providing $1E - 13$ after correction) in order to reduce the required OSNR and therefore to permit larger repeater spacing.

Examples of long haul optically amplified submarine networks using different types of FEC are listed in Table 2.

The overhead is the part of the signal transmitting the FEC code on top of the information data. In practice, this overhead is 7%: this means that the line rate is 10.7 Gb/s for a data rate of 10 Gb/s. In that case, the overhead in dB is $10 \operatorname{Log}(10.7/10) = 0.3 \text{ dB}$. More details on the different types of codes can be found in [5]. If a system like TAT 13 would be designed today with a 8.5 dB FEC net coding gain for a capacity of $1 \times 5 \text{ Gb/s}$, the repeater count would be 80 instead of 142: this demonstrates the high efficiency of FEC. The first generation of FEC was a Reed–Solomon (255;239) code and permitted to drop the requested Q factor before correction to 11.2 dB (Fig. 2(a)) with an overhead of 7% which leads to a net coding gain of $17.3 - 11.2 - 0.3 = 5.8 \text{ dB}$. This is the type of FEC used in FLAG-Atlantic 1 Networks linking the US to Europe (Fig. 3). The last generation of FEC [6] permits to drop the requested Q factor before correction to 8.5 dB with an overhead of 7% which leads to a net coding gain of $17.3 - 8.5 - 0.3 = 8.5 \text{ dB}$.

Table 2

Examples of long haul submarine networks using different types of Forward Error Correcting codes (FEC).

Network	Length (km)	Capacity (Gb/s)	Repeater spacing (km)	FEC NCG* (dB)	Date
TAT 13	6420	1 × 5	45	no FEC	1995
Columbus 3	7279	8 × 2.5	63	5.8	1999
Flag-A1	6473	42 × 10	41	7.5	2001
Asia–America–Gateway	6641	102 × 10	78	8.5	2008

* Where NCG is the Net Coding Gain of the FEC and is defined as follows: Net Coding Gain (dB) = Q after correction (dB) – Q before error correction (dB) – overhead (dB) for a B.ER. After correction equal to 1E-13.

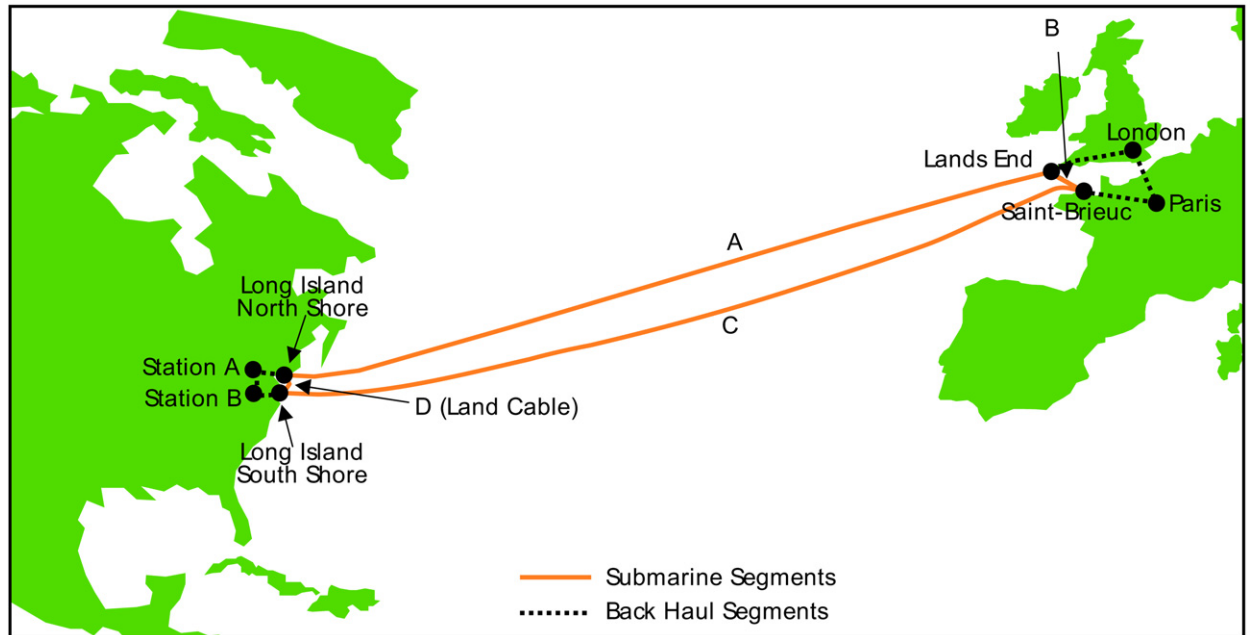

Fig. 3. The two trans-Atlantic links (A and C) of the FLAG-Atlantic-1 submarine system.

Note that in a laboratory experiment, the transmission quality to be demonstrated should be at least 3 dB above the FEC limit to account for industrial impairment, Q fluctuations over time, and margin for cable repair and repeater failures. This last generation of FEC is used in the Sydney–Hawaiï Network (9000 km, 64×10 Gb/s capacity per optical fiber) deployed in 2008 (Fig. 4). It can be noted that the theoretical Shannon's limit of the FEC net coding gain with 7% overhead is 9.5 dB (Fig. 2(b)) when a single decision threshold is used [5]. There is therefore not much improvement to expect in the future unless a higher overhead is used (which has the drawback to request higher line rate transmission) or unless a soft decision is used in combination with Turbo Codes [5].

3. Design of submarine links using Dispersion-Slope-Matched Fiber (DSMF)

3.1. Limitation of links designed with Non-Zero-Dispersion-Shifted Fibers (NZDSF)

All the WDM submarine links deployed until 2007 are using NZDSF, except TGN Pacific. This type of fiber has been described in [1] and its main disadvantage is the variation of its chromatic dispersion with wavelength. This results in very different cumulative amount of chromatic dispersion across the wavelength range as depicted in Fig. 5 (left). To reduce the cumulated chromatic dispersion at the end of the link, pre- and post-chromatic dispersion compensators are placed in the terminal station: this divides by a factor of two the amount of cumulated chromatic dispersion as shown in Fig. 5 (right).



Fig. 4. The Sydney–Hawai link across the Pacific ocean.

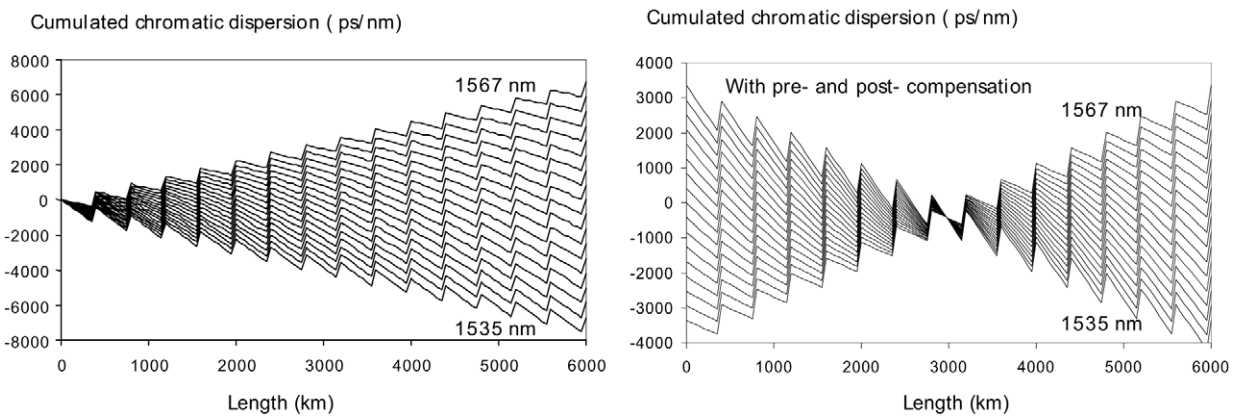

Fig. 5. Chromatic dispersion map of Non-Zero-Dispersion-Shifted Fiber (NZDSF) for different wavelengths without (left) and with (right) pre- and post-chromatic dispersion compensation in the terminal station.

When modulated by the RZ-OOK modulation scheme, the transmission quality is strongly degraded for the wavelengths located at the extremities of the wavelength range: this is demonstrated in a 70×10 Gb/s, 7300 km

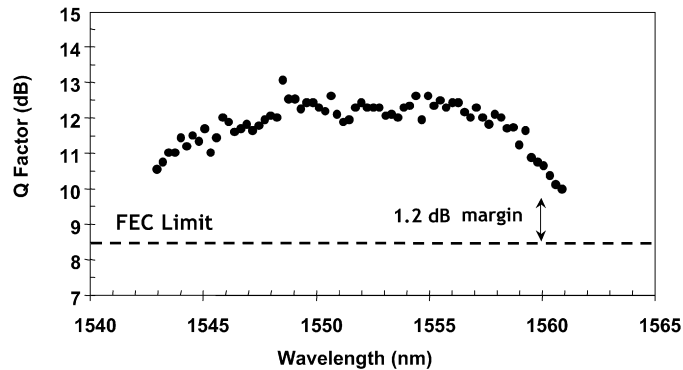

Fig. 6. Q factors of the 70×10 Gb/s RZ-OOK transmission performed over 7300 km of NZDSF.

transmission performed in Alcatel-Lucent Submarine Networks laboratories [7]: the Q factors recorded for the 70 wavelengths are depicted in Fig. 6.

As expected, the channels located at the extremities of the wavelength multiplex suffer from the high cumulative chromatic dispersion, resulting in a drastic Q factor degradation.

A slight improvement can be achieved for the outer wavelength of the multiplex by adding a synchronous phase modulation to provide the well-known Chirp-RZ (CRZ) OOK modulation format. Nevertheless, this technique does not permit dense wavelength multiplexing due to associated spectral broadening [1].

The performance of the system is given by the worst Q factor obtained over the wavelength range, which is 10 dB (which means 1.5 dB margin above the FEC limit) in the above laboratory experiment whereas the wavelength located in the middle of the spectrum exhibit a Q factor close to 13 dB.

The objective of the DSMF is to get rid of this Q factor variation across the wavelength range.

3.2. Design with Dispersion-Slope-Matched Fiber (DSMF)

As already described in [1], the principle of the DSMF is to cascade, in each repeater section, a length of Non-Dispersion-Shifted Fiber (NDSF) with a length of Reverse Dispersion Fiber (RDF). The RDF exhibits Chromatic Dispersion (CD) values opposite to that of the NDSF: as a result, the cumulated CD along the link is almost the same for all wavelengths. The CD of the RDF (resp. NDSF) is equal to -40 ps/(nm km) (resp. $+20$ ps/(nm km)) and its CD spectral variation is equal to -0.16 ps/nm² km (resp. $+0.08$ ps/nm² km). Therefore, 2/3 of the repeater span length is NDSF and 1/3 is RDF. The principle of a chromatic dispersion map based on DSMF is shown in Fig. 7: it should be noted that to reduce the non-linear interactions between the different wavelengths, it is mandatory to ensure a non-equal wavelength group velocity which means non-zero chromatic dispersion per repeater span: that is why the cumulated chromatic dispersion over one repeater span is adjusted to a value at least inferior to -50 ps/nm. As a result, after the propagation through 17 repeaters, the cumulated chromatic dispersion is about -900 ps/nm. Then the 18th repeater span is composed of conventional NDSF, thus permitting to compensate periodically every 18 repeaters for the -900 ps/nm cumulated chromatic dispersion. The characteristics of the NDSF and RDF being not perfectly opposite there is a non-zero (400 ps/nm) cumulated chromatic dispersion difference between the extreme wavelengths of the comb (1535 and 15675 nm) after 3000 km transmission as depicted in Fig. 7. This is less than 1/10th of the value observed at the same distance with NZDSF (Fig. 5).

A transmission experiment has been performed in Alcatel-Lucent Submarine Networks laboratories to demonstrate the efficiency of DSMF [8]:

121×10 Gb/s wavelength modulated with RZ-OOK modulation format are transmitted over 6500 km. The EDFA spacing is 75 km and the EDFA output power is $+17$ dBm (-4 dBm per wavelength). The Q factors recorded for the 121 wavelengths are depicted in Fig. 8.

The above experiment demonstrates the uniform transmission quality over the wavelength range. Moreover, the performance margin is 3.2 dB above the FEC limit, which is 2 dB better than the margin obtained with NZDSF for similar transmission length.

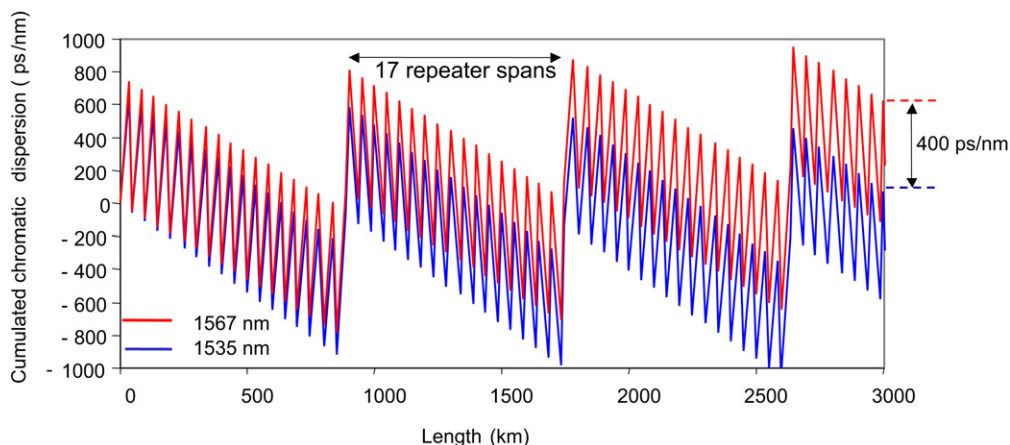

Fig. 7. Typical cumulated chromatic dispersion along the link using Dispersion-Slope-Matched-Fiber (DSMF) for the two extreme wavelengths 1535 nm and 1567 nm.

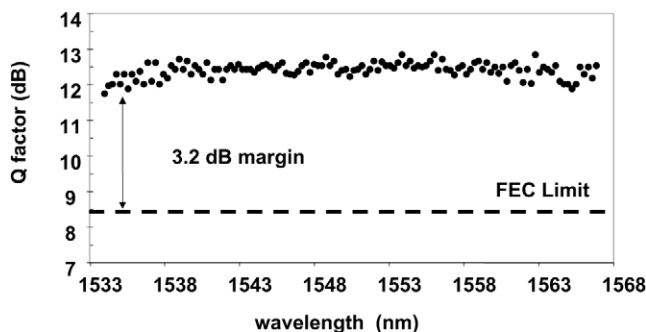

Fig. 8. *Q* factors of the 121 × 10 Gb/s RZ-OOK transmission performed over 6500 km of DSMF.

The first real submarine network to use DSMF was TGN Pacific linking the US to Japan in 2003 over a distance of 8991 km with a repeater spacing of 45 km and enabling the transmission of 64 × 10 Gb/s RZ-OOK modulated channel. Then due to the crash of the internet bubble, the market was oriented to low cost and low capacity networks and the DSMF has no longer been deployed, until 2008 when the market restarted to ask for Trans-Pacific Networks with high capacity. The only difference compared to TGN-Pacific is that these new networks designed in 2008 with DSMF are also taking benefit from this new modulation format called RZ-DPSK.

4. Introduction of DPSK modulation format in submarine networks

4.1. Principle of DPSK modulation scheme

The principle of the differential encoding and optical differential decoding with phase to intensity conversion as well as balanced receiver is depicted in Fig. 9.

As mentioned in the introduction, DPSK modulation can provide 3 dB OSNR margin over a OOK modulation scheme when a balanced receiver is used [3]. This has been experimentally demonstrated by measuring the BER versus different values of OSNR at the receiver input with RZ-OOK and RZ-DPSK modulation (without transmission fiber between the transmitter and the receiver) as depicted in Fig. 10:

The point is now to evaluate the robustness of DPSK modulation against non-linear effects and chromatic dispersion over long haul transmission.

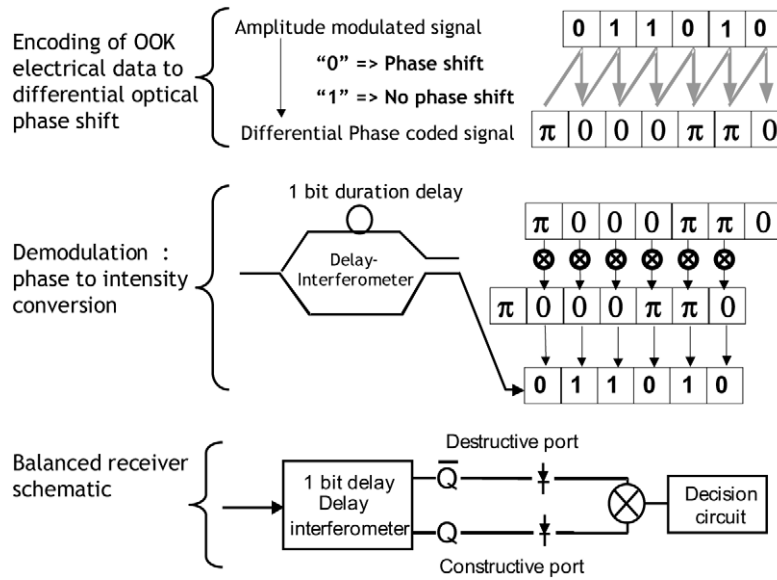

Fig. 9. Principle of the differential encoding and differential decoding with phase to intensity conversion and balanced receiver.

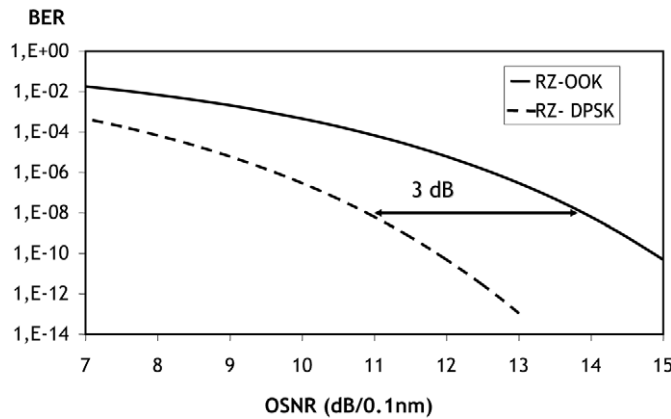

Fig. 10. BER versus different values of OSNR at the receiver input with RZ-OOK and RZ-DPSK modulation scheme.

4.2. Performance of 10 Gb/s DPSK over DSMF submarine links

To evaluate the performance of DPSK over DSMF, an experiment has been carried out in Alcatel-Lucent Submarine Networks laboratories [9]: this consists in the transmission of 124×10 Gb/s DPSK modulated channels over 12 380 km with an EDFA spacing of 75 km. The Q factor has been also recorded for a transmission length of 9380 km. In both cases, the EDFA output power is set to +17 dBm which corresponds to -1 dBm per wavelength.

Fig. 11 shows the Q factor performance recorded for the 124 channels for both distances, 9380 km and 12 380 km. The average performance recorded over the wavelength range is, respectively, 13.7 dB and 11.7 dB. Thus the minimal Q factor is 3.2 dB above the FEC limit at 12 380 km and 5.2 dB at 9380 km.

This Q factor obtained over 12 380 km with DPSK is similar to that obtained with the transmission of 121×10 Gb/s RZ-OOK modulated channels with the same EDFA spacing, but over a distance of only 6500 km. This demonstrates that we can almost double the transmission distance when replacing OOK modulation by DPSK modulation over DSMF links, which indicates that the 3 dB improvement of DPSK over OOK is also valid in presence of highly non-linear regime of transmission (ultra long haul).

This is the reason why the new submarine link that will link China to the US (the Trans-Pacific-Express Network, 11 500 km) and Sydney to Hawaiï (9200 km) in 2008 will use DPSK modulation scheme over DSMF. To demonstrate

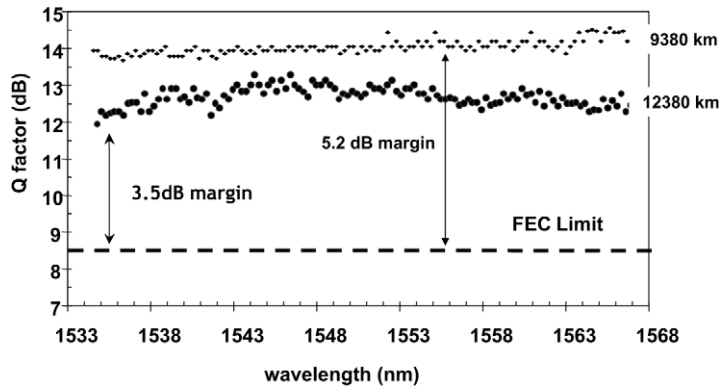

Fig. 11. Q factors of the 124×10 Gb/s RZ-DPSK transmission performed over 9380 km and 12380 km of DSMF.

Table 3

Examples of Trans-Atlantic and Trans-Pacific links designed with either OOK or DPSK modulation schemes.

Network	Length (km)	Modulation scheme	Repeater spacing (km)
FLAG-Atlantic 1	6500	CRZ-OOK	41
TGN Pacific	9000	RZ-OOK	45
Sydney-Hawaii	9200	RZ-DPSK	75

the impact of the RZ-DPSK modulation format on the repeater spacing, Table 3 gives the characteristics of some Trans-Atlantic and Trans-Pacific links.

From Table 3, we deduce that the use of RZ-DPSK instead of RZ-OOK permits one to significantly increase the repeater spacing compared to a design based on OOK modulation scheme.

4.3. Performance of 10 Gb/s DPSK over NZDSF submarine links

This concerns mainly the upgrade of existing links that have been deployed with NZDSF. The question is: can we take benefit from the 3 dB OSNR sensitivity improvement of DPSK over OOK to upgrade installed systems beyond their maximum capacity designed with OOK modulation?

For this evaluation, a transmission experiment has been performed with the following configurations [7]:

- 32×10 Gb/s CRZ-OOK modulation with 66 GHz wavelength spacing;
- 70×10 Gb/s RZ-OOK with 33 GHz wavelength spacing;
- 70×10 Gb/s RZ-DPSK with 33 GHz wavelength spacing.

The transmission length is 7300 km and the EDFA spacing is 61 km. The zero chromatic dispersion wavelength of the NZDSF is 1550 nm as depicted in Section 2.1 of this article. The results obtained with the three different modulation schemes are depicted in Fig. 12.

The FEC 1 is the first generation FEC featuring a 5.8 dB net coding gain (Reed–Solomon [255;239]).

The FEC 2 is the last generation FEC featuring a 8.5 dB net coding gain.

As expected, the OOK modulation schemes exhibit transmission quality degradation for wavelengths experiencing large cumulated chromatic dispersion.

Concerning RZ-DPSK, the behaviour is the opposite: the wavelengths located close to the zero chromatic dispersion wavelength exhibit strong quality degradation whereas the wavelengths experiencing large cumulated chromatic dispersion exhibits very good performances.

The performance degradation in the zero chromatic dispersion wavelength with RZ-DPSK modulation is due to Kerr induced non-linear interactions with the amplified spontaneous emission of the EDFA which induces phase distortion [10].

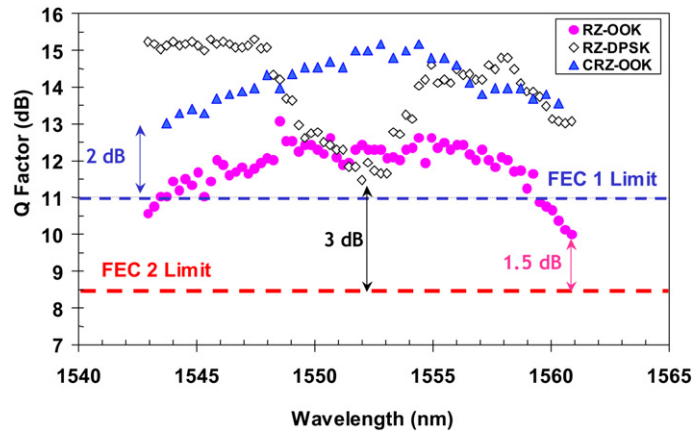

Fig. 12. Q factors recorded in a 7300 km NZDSF transmission with the three following transmission capacities: (a) 32×10 Gb/s CRZ-OOK modulation with 66 GHz wavelength spacing. (b) 70×10 Gb/s RZ-OOK with 33 GHz wavelength spacing. (c) 70×10 Gb/s RZ-DPSK with 33 GHz wavelength spacing.

Nevertheless, we can see that taking benefit from the FEC efficiency improvement, the use of a RZ-DPSK modulation scheme enables one to double the initial transmitted capacity designed with first generation FEC and CRZ-OOK modulation. In addition, the system performance margin is increased from 2 dB to 3 dB.

In consequence, to upgrade existing systems deployed with NZDSF, it can be useful to mix the two different modulation schemes: OOK for wavelengths close to the zero dispersion wavelength and DPSK for the other wavelengths located at least 3 nm away from the zero chromatic dispersion wavelength. In such mixed modulation schemes systems, it is however mandatory to insert a small guard band (typically 0.6 nm) between the center OOK modulated wavelengths and the outer DPSK modulated wavelengths to avoid drastic performance degradation of the DPSK wavelengths adjacent to the OOK comb [7].

5. Towards WDM 40 Gb/s transmission in submarine networks

The transmission of 40 Gb/s bit rate per wavelength is now becoming a reality in terrestrial networks. As a consequence, it is mandatory to consider the possibility to transmit such high bit rate modulation through the oceans. The challenges are different from terrestrial systems due to the very long distances to be achieved in submarine field (more than 6000 km to cross the Atlantic). This is why the technical solutions that could fit for terrestrial system are not automatically adequate for submarine links. In the following, we will present the different modulation schemes which are currently tested in laboratories to break the 6000 km distances for WDM 40 Gb/s transmission. Again, we will consider the two different types of system targeted: the upgrade of already deployed links (using NZDSF) and the development of new links (using DSMF).

5.1. Design of new links for WDM 40 Gb/s capacity over more than 6000 km

In order to be competitive versus WDM 10 Gb/s solutions, the design of WDM 40 Gb/s links should not induce a significant increase of the repeater count, knowing that for a WDM 10 Gb/s RZ-DPSK 6500 km link using DSMF, the repeater spacing proposed today is close to 85 km (75 km for a 9000 km link deployed between Sydney and Hawaiï).

Also, due to the larger spectral width induced by higher speed modulation, the typical wavelength spacing of WDM 40 Gb/s transmission is 100 GHz (0.8 nm) which is equivalent to 25 GHz (0.2 nm) for a WDM 10 Gb/s system in term of spectral efficiency (expressed in Gb/s/nm).

The electrical bandwidth of a 40 Gb/s receiver is four times the one of a 10 Gb/s receiver which leads automatically to an OSNR sensitivity degradation of 6 dB as illustrated by Fig. 13.

One way to compensate for this 6 dB OSNR sensitivity penalty would be to increase the optical power per channel. In other words, is it possible to increase the maximum optical power per 40 Gb/s modulated wavelengths compared to 10 Gb/s modulated wavelengths in presence of non-linear effects?

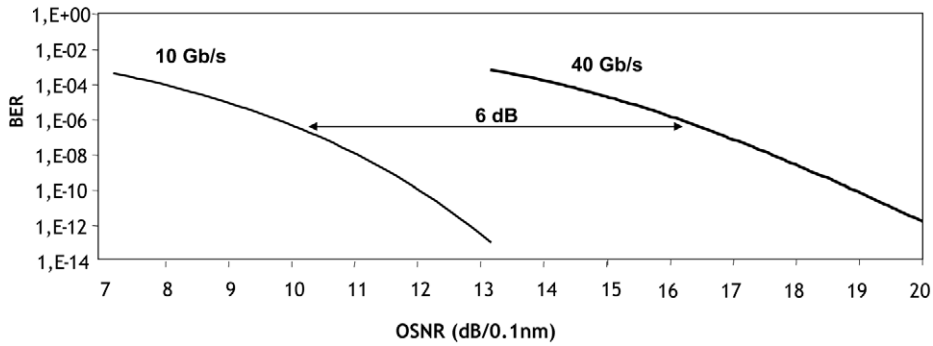

Fig. 13. BER versus different values of OSNR at the receiver input with 10 Gb/s and 40 Gb/s RZ-DPSK modulation scheme.

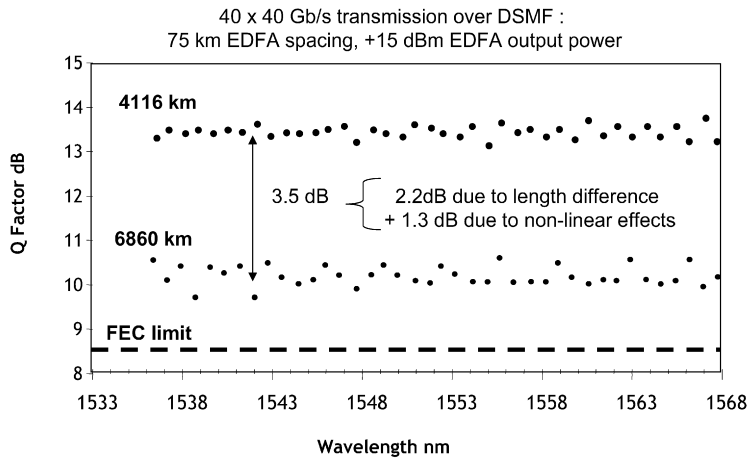

Fig. 14. Q factor recorded in a 40×40 Gb/s RZ-DPSK transmission performed over 4100 km and 6860 km of DSMF.

In order to check that the power per 40 Gb/s wavelength can be increased compared to 10 Gb/s wavelengths, a transmission experiment has been performed in Alcatel-Lucent Submarine Networks laboratories where a 40×40 Gb/s RZ-DPSK transmission has been achieved over 4100 km and 6860 km of DSMF. The Q factor recorded for the 40 wavelengths are depicted in Fig. 14. When increasing the transmission length from 4100 to 6860 km at constant output power and EDFA spacing, the OSNR degradation is $10 \text{Log}(6860/4100) = 2.2$ dB. When considering the average Q factor at 4100 km (13.5 dB) and 6860 km (10 dB) we observe a Q degradation of 3.5 dB, which means that the penalty due to non-linear effects is equal to 1.3 dB at 6860 km. Higher EDFA output power leads to a drastic degradation due non-linear effects. In this experiment, the optical power per wavelength at each EDFA output is -1 dBm which is about 3 dB higher than the optical power per wavelength at 10 Gb/s (see Section 2.2). In conclusion, the optimum EDFA output power at 40 Gb/s can be 3 dB higher than at 10 Gb/s which is fine but not sufficient to compensate totally for the 6 dB OSNR sensitivity degradation. It can also be noted that the average Q factor is only 10 dB over 6860 km, which is lower than the 3 dB margin above the FEC limit requested to account for the industrial impairment, long term Q fluctuations and cable repairs as well as repeater failures as mentioned in Section 1. The consequence is that either the repeater spacing has to be reduced below 65 km which would be cost prohibitive compared to WDM 10 Gb/s system where the repeater spacing is about 85 km, or another modulation format should be introduced.

A new modulation format that is considered to improve the transmission of WDM 40 Gb/s transmission quality over more than 6000 km is using alternate polarisation between adjacent bits [11]. This is the so-called APol-RZ-DPSK modulation format: the principle is to reduce the non-linear interactions between adjacent bits by rotating by 90° the polarisation between two adjacent bits as depicted in Fig. 15. Note that due to the polarisation alternation, the receiver is composed of a 2-bit delay interferometer (instead of 1-bit delay for non-alternate polarisation scheme).

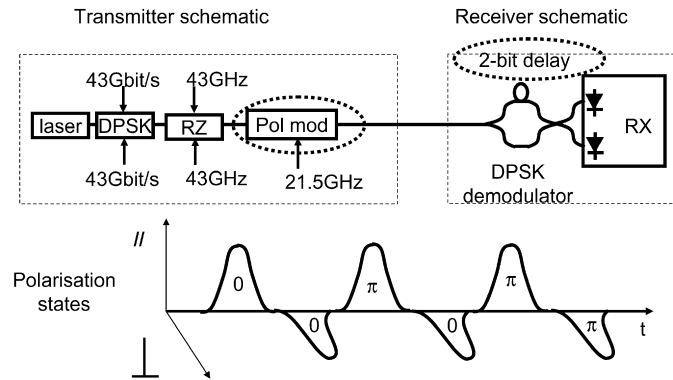

Fig. 15. Principle of the Alternate-Polarisation modulation scheme.

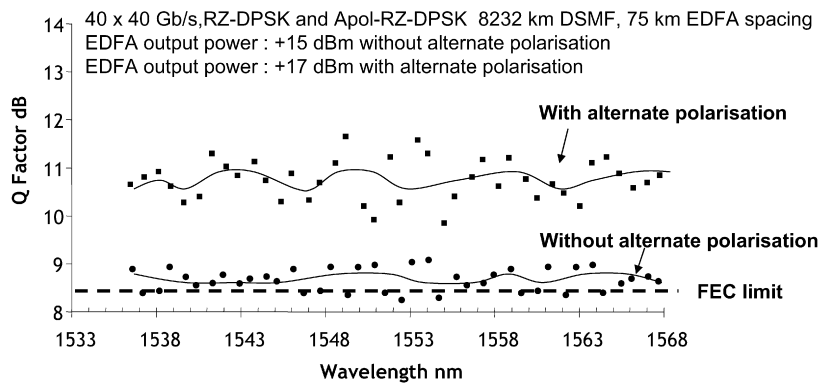

Fig. 16. Q factors recorded in a 40×40 Gb/s transmission experiment performed over 8232 km DSMF.

To demonstrate the efficiency of this modulation scheme a 40×40 Gb/s transmission experiment has been performed in Alcatel-Lucent Submarine Networks laboratories over 8232 km DSMF with a 75 km EDFA spacing. The EDFA output power per wavelength is -1 dBm for the RZ-DPSK transmission and $+1$ dBm for the APol-RZ-DPSK transmission. The Q factor recorded for the 40 wavelengths are depicted in Fig. 16 for the two modulation schemes.

The results show that the use of the alternate polarisation permits to increase by 2 dB the power per wavelength thanks to the reduction of the non-linear interactions in case of orthogonal polarisation between adjacent bits. As a consequence, the average Q factor is about 11 dB with the APol-RZ-DPSK scheme which represents 2.5 dB improvement compared the Q factor obtained without alternate polarisation: this should be, however, compared to the better performance achieved with 10 Gb/s technologies where an average Q factor of 13.7 dB has been recorded over 9380 km with a 75 km EDFA spacing and a total capacity of 1.24 Tb/s (but with a different information spectral density) (see Section 3.2, Fig. 11).

Another candidate modulation format to transmit WDM 40 Gb/s capacity over more than 6000 km is the so-called “interleaved” Polarisation Division Multiplexed (PDM) – Binary PSK modulation scheme [12]. Since this modulation scheme uses PDM, the receiver should include a coherent detection technique to ensure perfect polarisation separation in an industrial environment: the principle and interest of coherent receiver is described in another article of this present issue of the *Compte Rendus Physique* by Gabriel Charlet. Recently, a 50×40 Gb/s transmission experiment over 5200 km has been performed [13] using this format where two data streams modulated at 20 Gb/s RZ-DPSK are combined through an optical polarisation beam combiner with a half bit duration time delay between the two streams: this principle is illustrated in Fig. 17 where the pure alternate polarisation at 40 Gb/s and the polarisation multiplexing of two 20 Gb/s modulation schemes are compared. Using this technique, a 2.5 dB Q factor improvement over standard 40 Gb/s RZ-DPSK modulation has been reported with a 66 GHz wavelength spacing (40 Gb/s RZ-DPSK is strongly penalised by this narrow wavelength spacing inducing a spectral crosstalk between the adjacent wavelengths). It should be noted however that the interleaved PDM 20 Gb/s RZ-DPSK transmission quality is very

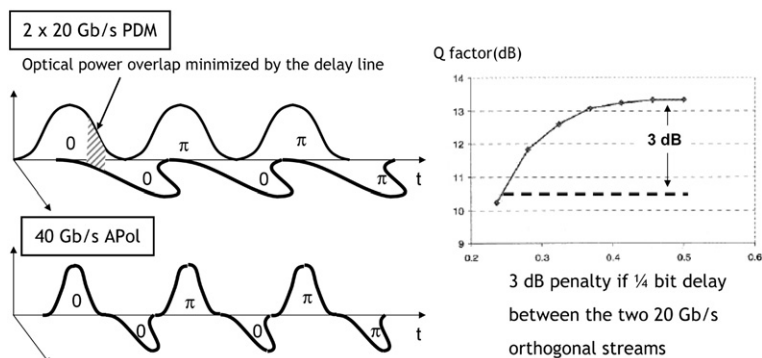

Fig. 17. Principle of dual polarisation (2×20 Gb/s) modulation scheme with half bit duration delay.

sensitive to the time delay between the two 20 Gb/s data streams: a 3 dB performance degradation is observed when the time delay is $1/4$ instead of $1/2$ of the bit duration and loss of data is observed for $1/5$ of the bit duration as shown in Fig. 17. Nevertheless, this technique seems promising to realize WDM 40 Gb/s submarine transmission over long distances with a dense wavelength multiplexing.

Concerning the upgrade of existing systems, the use of 40 Gb/s modulation can be considered if the link to be upgrade has the following characteristics:

- medium haul link (below 5000 km);
- designed with OOK modulation;
- designed with old FEC generation.

In this case, the use of last generation FEC plus the 3 dB benefit of DPSK over OOK can compensate the 6 dB OSNR gap to be filled by moving from 10 Gb/s to 40 Gb/s.

In summary, the deployment of 40 Gb/s modulation in submarine networks will request more repeaters WDM 10 Gb/s according to the current results obtained in laboratories. Nevertheless, if a customer requests a city-to-city direct 40 Gb/s “clear channel” through the concatenated terrestrial and submarine paths, this will be possible, at the cost of higher repeater count in the submarine part.

6. Conclusion

In our previous paper of the *Compte Rendus Physique* (2003), we have shown how the 1995–2002 period has been fruitful as far as capacity increase is concerned: from 1×5 Gb/s, the capacity increased up to 42×10 Gb/s (FLAG-Atlantic-1) over trans-Atlantic distances. In 2003, Tyco deployed a trans-Pacific link of 9000 km using for the first time a new type of correct fiber (DSMF). However, due to the collapse of the internet market within the 2002–2007 period, no new technologies have been deployed: no Raman amplification, nor C + L band EDFA, always the same WDM 10 Gb/s intensity based modulation formats and no further deployment of the DSMF. The objective during this period was not to transmit higher capacity but to reduce the system cost by reducing the repeater count. This target is now achieved in 2008, thanks to the improvement of the error correcting code efficiency but mainly through the introduction of a new modulation format based on phase shift modulation combined with the wide deployment of DSMF: the number of repeaters requested to cross trans-oceanic distances is divided by two compared to system using intensity modulation and standard non-zero-dispersion-shifted fibers: the repeater spacing has moved from 42 km in FLAG-Atlantic-1 system (6400 km, 42×10 Gb/s capacity) to 75 km in Sydney-Hawaiï system (9200 km, 64×10 Gb/s capacity) which is currently being deployed by Alcatel-Lucent Submarine Networks. The future will probably address the challenge raised by WDM 40 Gb/s transmission over trans-oceanic distances. Although technical solutions exist this is still at the cost of a much higher repeater count compared to 10 Gb/s based solutions. This is the challenge that we have to face now since the market is more and more requesting direct 40 Gb/s “clear channel” services from city-to-city including the concatenated terrestrial and submarine paths.

References

- [1] O. Gautheron, M. Suyama, Submarine cable networks, *C. R. Physique* 4 (1) (2003) 115–126.
- [2] M. Murakami, T. Matsuda, T. Imai, in: *Proc. European Conference on Optical Communications, ECOC'98*, Madrid, Spain, 1998, pp. 79–81.
- [3] A.H. Gnauck, P.J. Winzer, Optical phase shift keyed transmission, *Journal of Lightwave Technology* 23 (1) (January 2005) 115–129.
- [4] P.A. Humblet, M. Azizoglu, On the bit error rate of lightwave systems with optical amplifiers, *Journal of Lightwave Technology* 9 (1991).
- [5] J. Chesnoy (Ed.), *Undersea Fiber Communication Systems*, Academic Press, 2002.
- [6] O. Aït Sab, FEC evolution in submarine transmission systems, in: *SubOptic Conference 2004*, Monaco, paper We 10.1.
- [7] S. Dupont, et al., 70×10 Gbps (mixed RZ-OOK and RZ-DPSK) upgrade of a 7224 km conventional 32×10 Gbps designed system, in: *European Conference on Optical Communications, ECOC'07*, paper Mo.2.3.5.
- [8] P. Plantady, et al., DPSK Transmission experiments over DSMF and NZDSF DPSK transmission experiments over DSMF and NZDSF, in: *Sub'Optic Conference 2007*, Baltimore, paper ThB17.
- [9] L. Du Mouza, et al., 124×10 Gbits/s RZ-DPSK transmission over 12 380 km without channelized chromatic dispersion management, in: *Proceedings of Optical Fiber Communication Conference OFC'07*, paper OThS3.
- [10] W.T. Anderson, et al., Modeling RZ-DPSK transmission – simulations and measurements for an installed submarine system, in: *Proceedings of Optical Fiber Communication Conference OFC'05*, paper OThC1.
- [11] G. Charlet, et al., Alternate-polarisation RZ-DPSK transmission at 40×42.7 Gbit/s over transpacific distance with large Q-factor margin, in: *European Conference on Optical Communications, ECOC'04*, post-dead-line paper.
- [12] X. Liu, et al., Performance analysis of time-polarisation multiplexed 40 Gb/s RZ-DPSK DWDM transmission, *IEEE Photonics Technology Letters* 16 (1) (January 2004) 302–304.
- [13] J.X. Cai, et al., 40 Gb/s transmission using polarisation division multiplexing (PDM) RZ-DBPSK with automatic polarisation tracking, in: *Proceedings of Optical Fiber Communication Conference OFC'08*, post-dead-line paper PDP 4.